

saxun<sup>®</sup>  
by Giménez Ganga

# P-230

Bioclimatic Pergola

new



**saxun**<sup>°</sup>  
Your world, our universe.



## Bioclimatic Pergola P-230

# An oasis of absolute comfort

Imagine a space where comfort and elegance merge to perfection.

Our new Bioclimatic Pergola P-230 is specially designed to offer impressive dimensions of 7x5.6 metres (length x width), in all its typologies.

An innovative solution that guarantees a totally open and free space for your enjoyment, whether in residential or HORECA environments.

A Pergola that is notable for its modern and aesthetic design as well as for its robustness and reliability.

Thanks to its advanced engineering, it allows you to enjoy up to 39.2m<sup>2</sup> of living space, and ensures total stability of the slats and other elements that make it up.

Under the new P-230, every moment outdoors becomes an unrivalled experience of comfort and well-being, ensuring the enjoyment of the best environment, in safety and style.



# Spacious, solid and minimalist

Our new large Bioclimatic Pergola has been created to cover wide open spaces.

A new design with an extra touch of elegance and aesthetics, thanks to the minimisation of profiles and screws. Its system of adjustable columns

and slat installation system make it easy to assemble and install, while guaranteeing a high-quality professional finish.



7x5.6 m  
Maximum dimension



Better aesthetics



Easy installation







New lighting system

## Adjustable columns

The adjustable column makes installation much easier and more efficient, as it provides greater and better accessibility for installation.

All columns are composed of two profiles to access them.

In addition, they come pre-installed and ready for installation and maintenance.

-  Fast assembly that allows you to optimise your time and make your projects even more profitable.
-  Easy installation that increases the efficiency of installations.
-  Tastefully constructed to provide a cleaner finish, thanks to the concealment of screws.
-  It allows the integration of other Saxun solutions, such as glass sliding curtains, drop awnings, wind screens or window and door shutters.

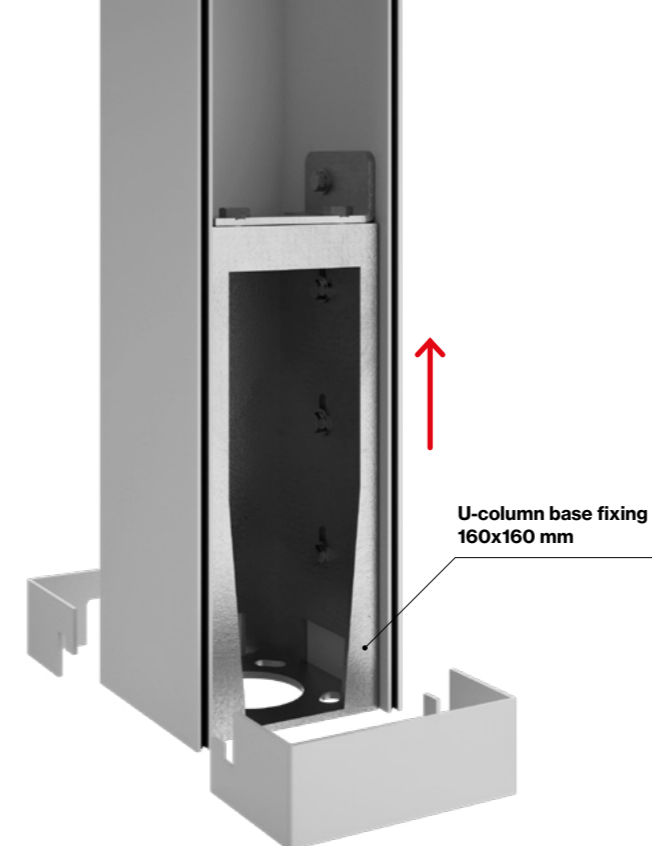

## Adjustable base

The columns include a sturdy steel base inside to reinforce their attachment to the floor. In addition, it can be adjusted in height, with a tolerance of +1.5 cm to overcome any unevenness in the floor.

For aesthetic reasons, the screws at the base of the columns are concealed inside.

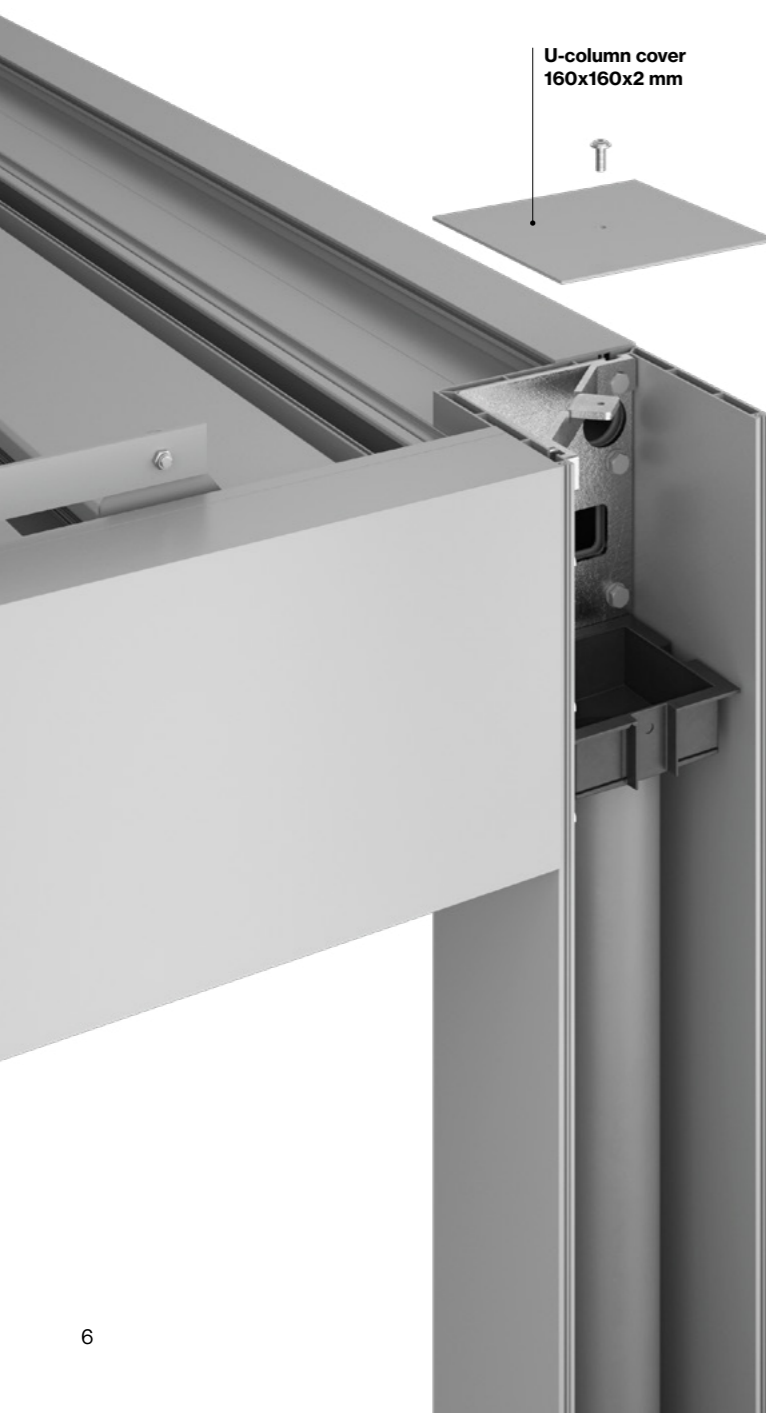

## P-230 slat

Extruded aluminium adjustable slat, finished at the ends with aluminium end caps, with retractable stainless steel shaft and anti-friction plastic bushing.

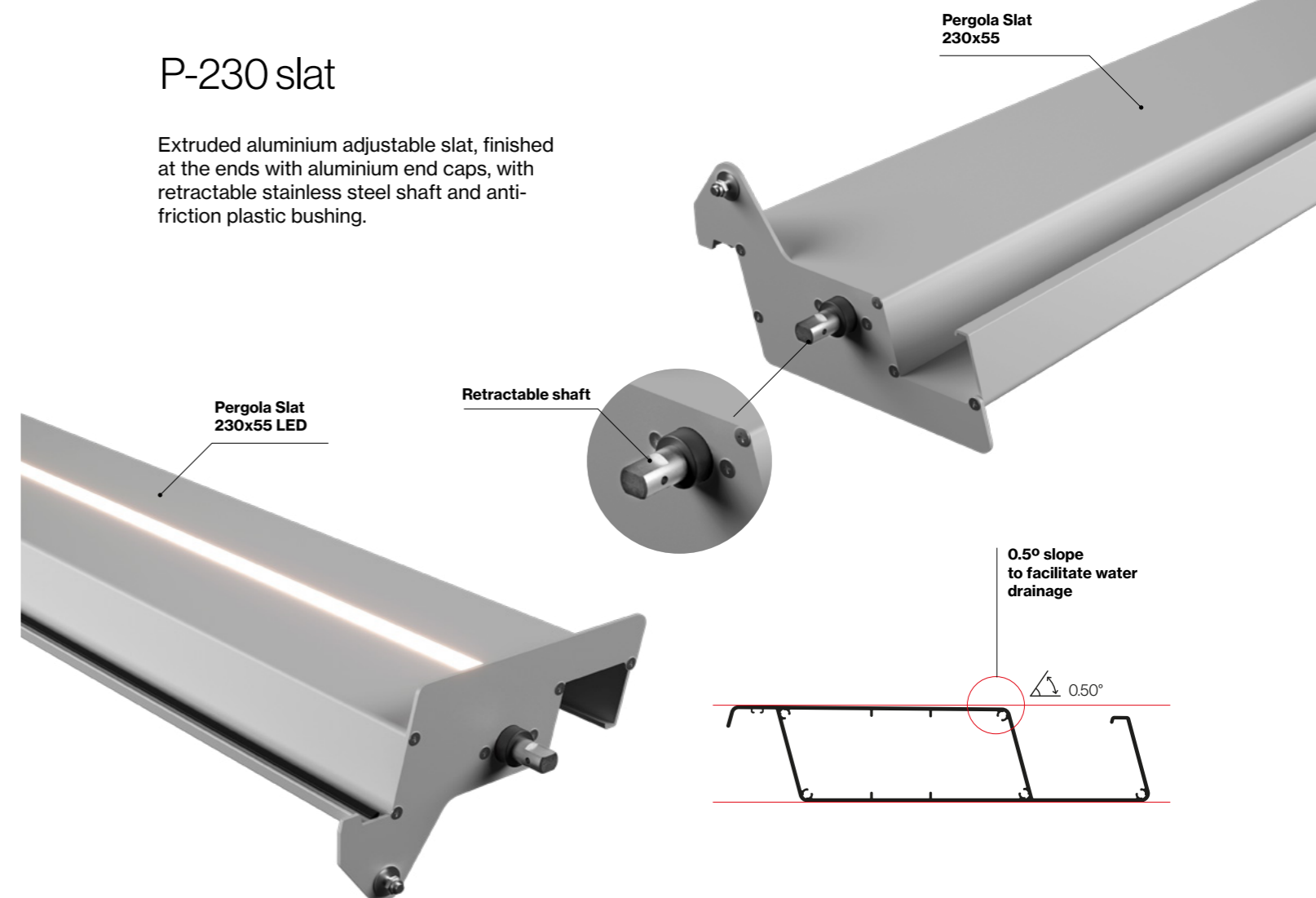
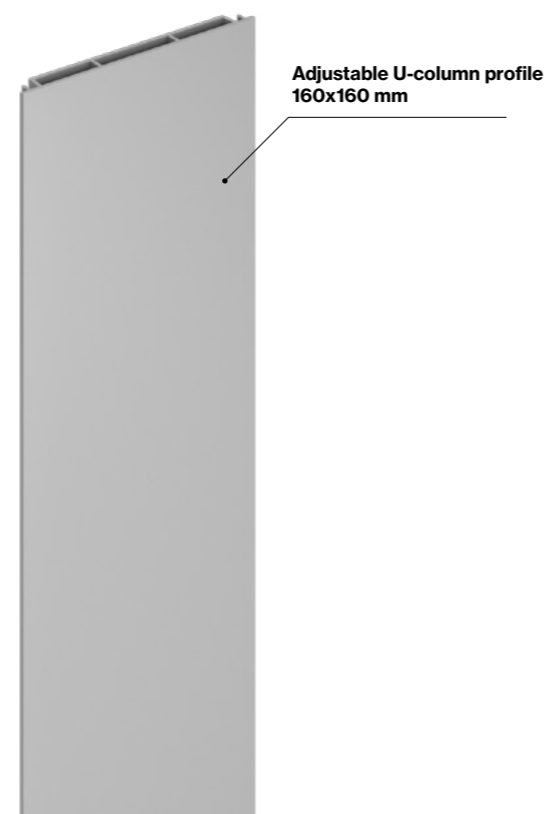

## New beam

The gutter is integrated into the new beam, so that we no longer have to add a new profile to channel the water to the columns.

In the lower part of the profile we have a double chamber to screw other Saxun products such as Glass Curtains, Wind Screens, Shutters, etc.

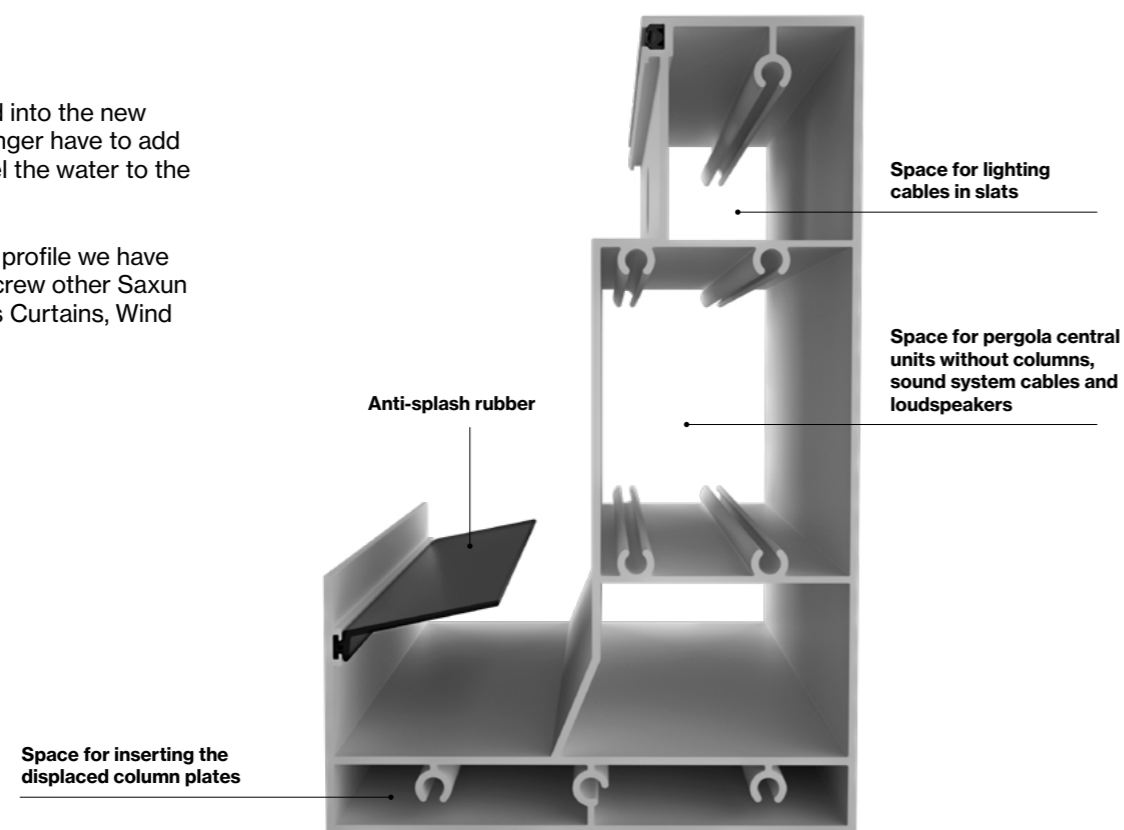

## Rainwater collection

New technical rubber gasket system to reinforce the joint areas between the column and the beam. One per column, depending on the drainage configuration.

There are two water-drainage systems; free drainage to the ground.

### Free water drainage

The water from the gutters is introduced into the interior of the column, which acts as a downspout, expelling the water to the outside through an opening at the bottom of the column.



## Easy assembly system

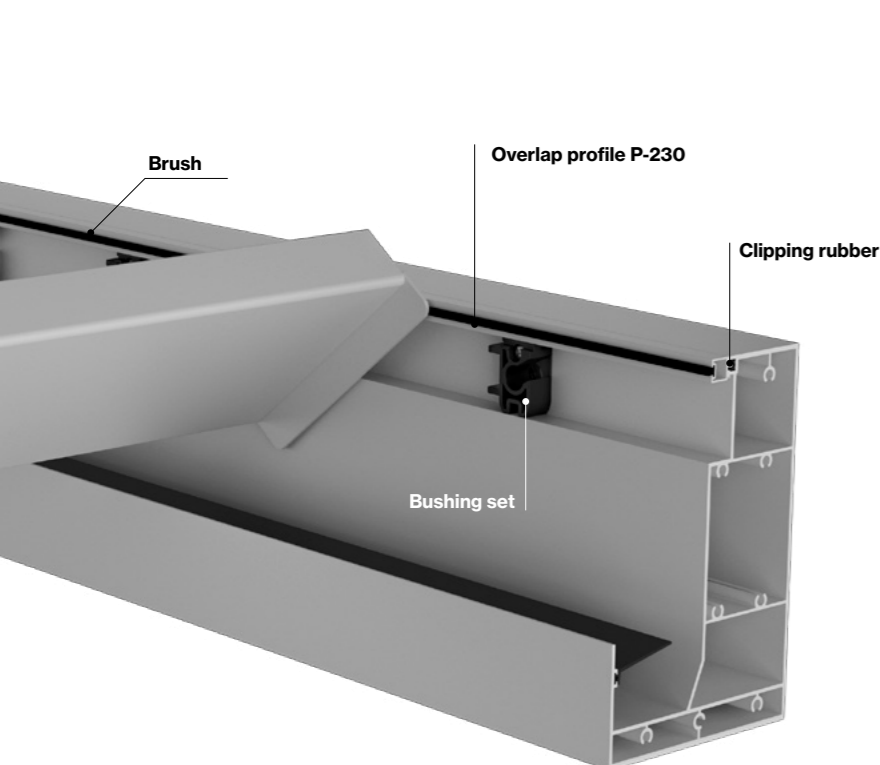

### Step 1

Place the slat in the assembly position in order to insert the slat shaft into the beam bushing. Rotate the slat until the flat faces of the shaft and the bushing are in the same direction.

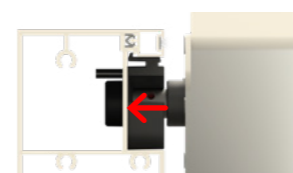

### Step 2

While the slat is tilted, push the shaft towards the inside of the slat so that it can be inserted into the bushing. First place one shaft and then the other.

### Drainage channelled through the ground

Through the collection tray, the water from the gutters is channelled to a PVC pipe inside the column for connection to the sewage system.

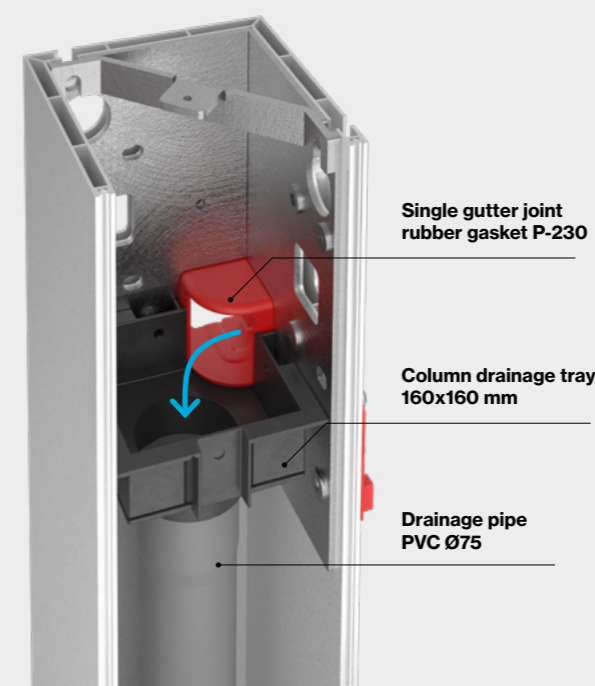

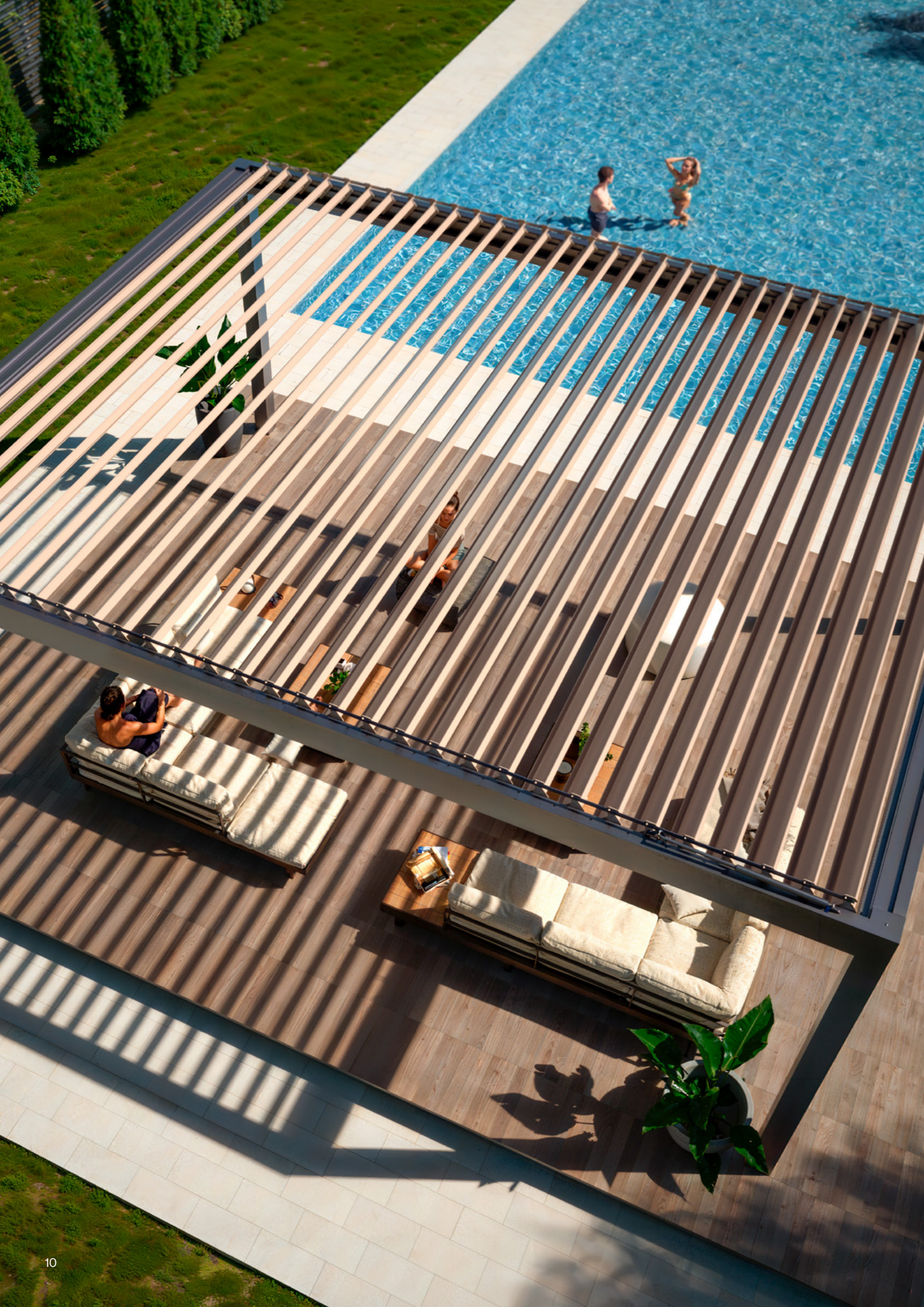

## Bioclimatic effect

The slats of our Bioclimatic Pergolas rotate from a closed position to an open position, up to 135°.

The system generates pleasant natural ventilation by heating the louvres when they are exposed to solar radiation.

This produces a natural convection movement of air from the bottom up, through the slats.

An adjustable effect by turning the slats, with which we also control the entry of the desired sunlight into the space created by the pergola itself.

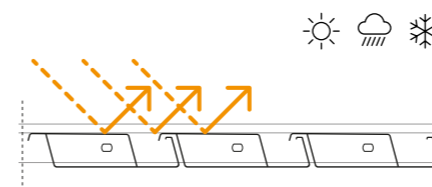

**0°** The roof is sealed and provides total protection against the most harmful solar radiation, as well as the most extreme weather conditions.

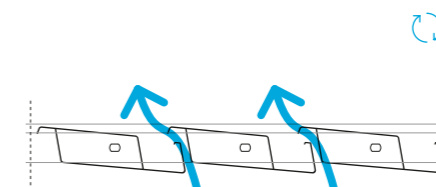

**5°** It permits excellent room ventilation, maintaining shade when it is sunny, or protecting against water when it rains.

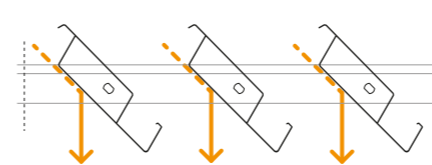

**45°** Enjoy natural ventilation, controlling the direction of the sun's rays and their intensity.

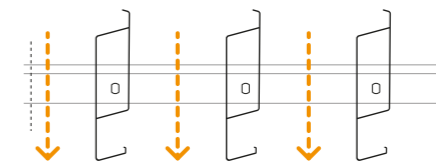

**90°** Opening the slats allows full use of the light, even when it is scarce.

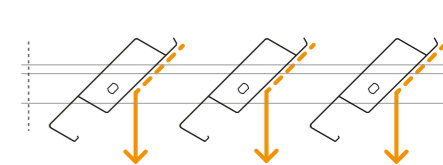

**135°** Maximum inclination that lets sunlight come through even when it starts getting dark.

## Profiles

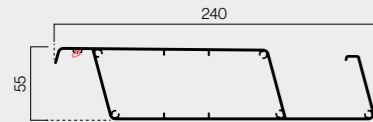

Pergola Slat 230x55 mm  
050522

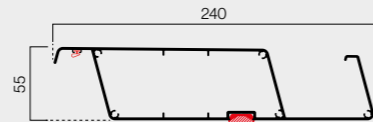

Pergola Slat 230x55 LED  
050521

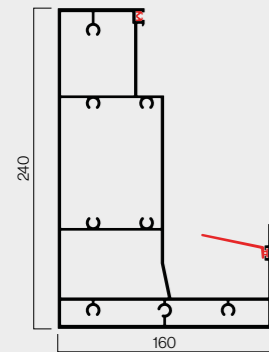

Beam P-240x160 mm  
050618

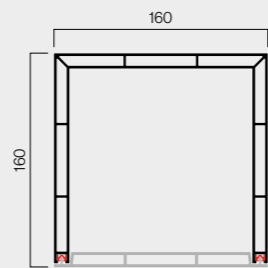

Open U-column 160x160  
050610

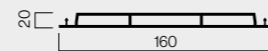

U-column adjustment profile  
160x160 mm  
050609

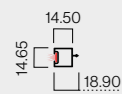

Overlap profile P-230  
050727



Transmission plate profile  
30x4  
507162



Perimeter LED profile  
050491

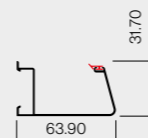

Clipping collector  
050208

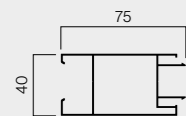

Clip-on adapter  
40x75  
050327

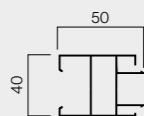

Clip-on adapter 40x50  
SOFT  
050218



## Configurations



4 columns

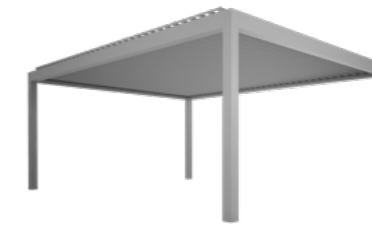

3 columns



2 columns



1 column

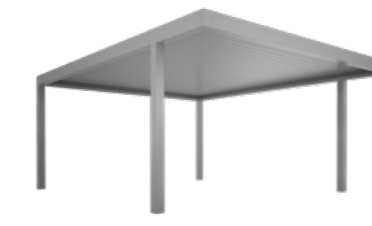

Displaced column



No columns

## Maximum dimensions

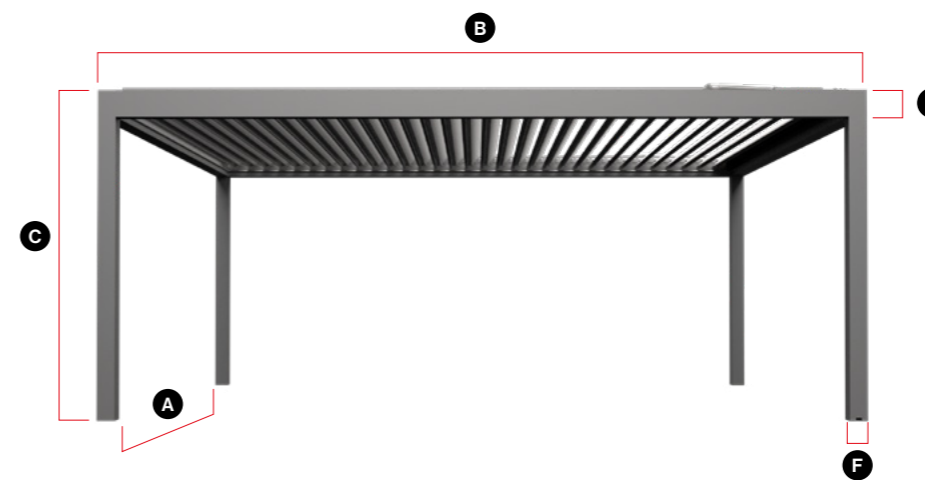

<b>A</b> Maximum tested width	5600 mm
<b>B</b> Maximum tested length	7000 mm
<b>C</b> Maximum height	3000 mm
<b>D</b> Beam dimensions	240 mm
<b>F</b> Column dimensions	160x160 mm
Minimum inclination	0%
Type of drainage	Free/Ground

## Testing

Our pergolas are subjected to the most diverse tests carried out at our laboratory so that we can check their resistance and performance under all kinds of conditions.

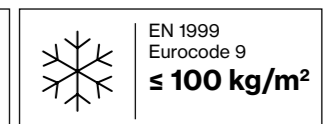
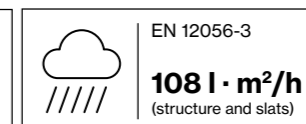
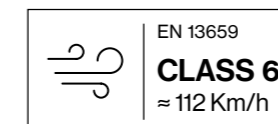

## Automated systems/Transmitters

### NOON Transmitter (63 channels)

- Up to 9 channels and 7 buttons per channel  
With one transmitter we can control:
  - Slats of 1 pergola.
  - 1-colour LEDs.
  - RGB LEDs.
  - Heating.
- 4 buttons for pre-set positions, plus 3 for close control.
- Available in black and white.



NOON Transmitter White Aluminium.

NOON Transmitter Black Aluminium.

### Rain and outdoor temperature sensor

- Temperature sensor external to the control unit.
- Rain sensor with integrated heating function to avoid misinterpretation of rainfall.
- IP-65 protection.



## Motorisation

The 24 V mechanical motor, with IP-66 protection, installed on the P-240x160 beam of the pergola, drives the movement of the slats by means of a double transmission with a drive plate.

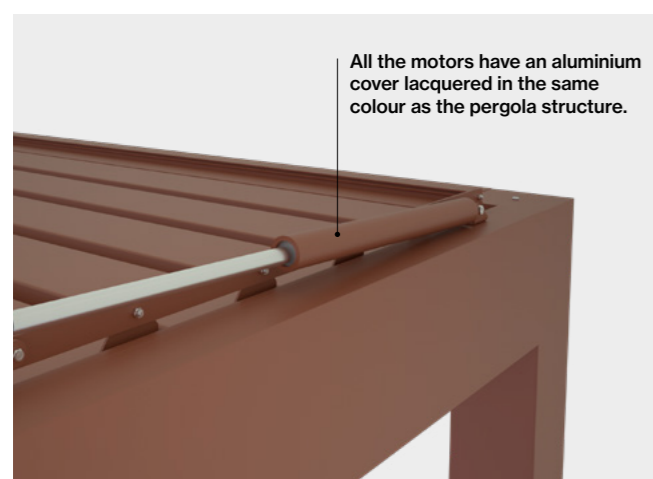

## Accessories

### Infra-red heating



### Power socket 230V



### Sound system



## LED lighting

The new lighting options help create spaces with greater ambience possibilities; more welcoming, and ideal for residential use as well as for restaurants and hotels.

New LED strips (both for slats and the structure's perimeter), portholes and fittings for columns, which increase the value of your Pergola. Installation of these new accessories is also much more convenient and quicker for professionals.

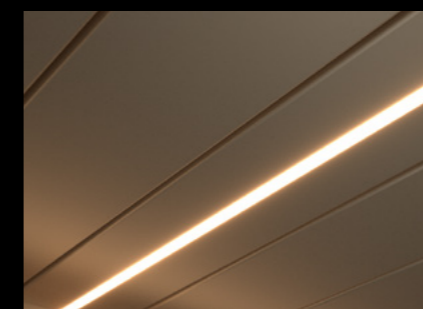

### LED perimeter/slats

- Integrated LED silicone folding profile.
- Consumption: <8 W/m.
- LED strip with diffuser.
- IP-65 protection.
- Easy replacement.
- Kits of 5 LED strips.
- 2-pin (1 colour) or 4-pin (RGB) quick connector.
- 4, 5 and 7 m strips. The 5 and 7 m strips are supplied with connectors at both ends.



### Portholes

- For use on slats.
- Kits of 2, 3 or 5 portholes per slat.
- Low consumption.
- Spotlight in colour anodised aluminium.
- Vision angle 60° (full diffusion).
- IP-54 protection.
- 24V power supply.



### Fittings

- For use on columns.
- Mono-emission or bi-emission.
- They bring a more elegant look to the space.
- Ideal for Hospitality or Contract spaces.



## Colours and finishes

To adapt to all aesthetic requirements or to create totally disruptive spaces, the choice of colour is fundamental. This is why your Saxun pergola has no limits; you can choose any colour from the RAL chart, anodised colours and woods, in glossy, matt and textured finishes (for even greater weather resistance).

A customised finish that guarantees excellent performance against solar radiation, rain or snow, thanks to the quality of the aluminium, the paint used, and the lacquering process itself.

Our state-of-the-art lacquering process is based on Qualicoat prescriptions (international quality seal for lacquered aluminium that guarantees its quality for use in architecture) and allows a wide variety of processes and high-performance finishes that adapt to every requirement:

- General multi-metal process (not Qualicoat).
- Equivalent to standard Qualicoat.
- For installations exposed to the sea, we can offer a superior quality of Qualicoat, which is the Seaside Class. Within this classification, the AA1 fully coincides with the Qualimarine seal, awarded by the French Association (ADAL).



The shades of these colour are for guidance only. There could be a difference with the actual colour due to the printing process.



7016 TX (Structure) Silver TX (Slats)

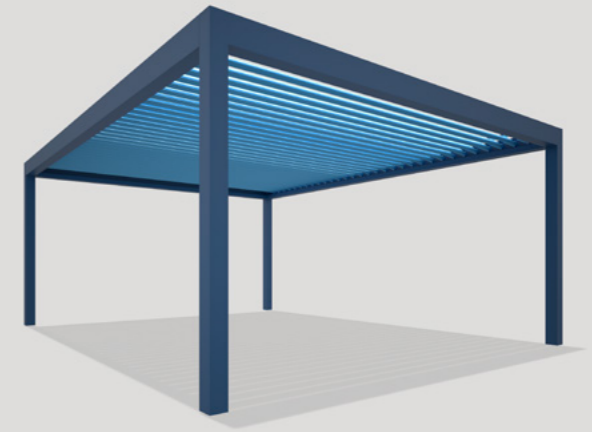

5019 TX (Structure) 5024 TX (Slats)

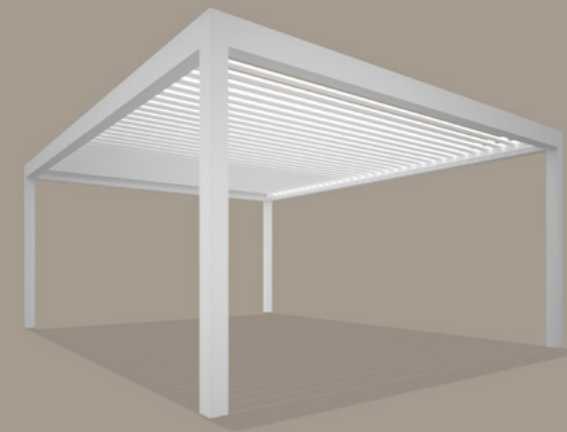

9016 TX

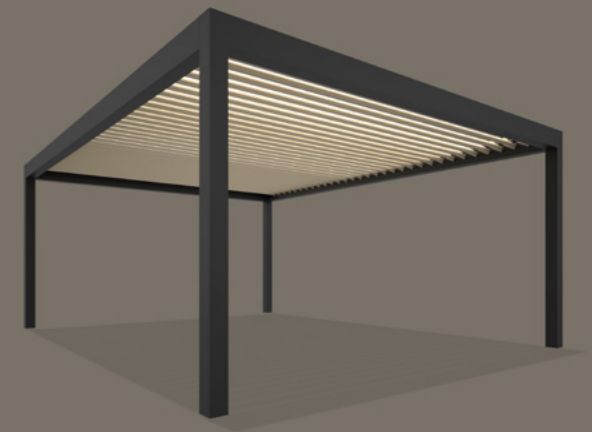

9005 TX (Structure) 1013 TX (Slats)



Oxicobre

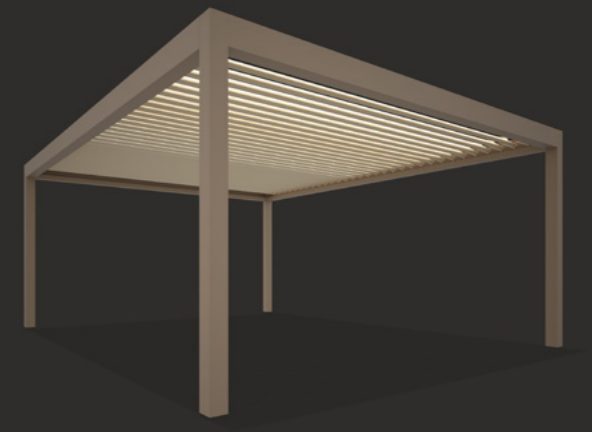

1019 TX (Structure) 1013 TX (Slats)

# Accessories

The solid and resistant extruded aluminium structure of our Bioclimatic Pergola guarantees a stable base to incorporate other Saxun Enclosures and Solar Protection solutions, expanding the possibilities of your space.

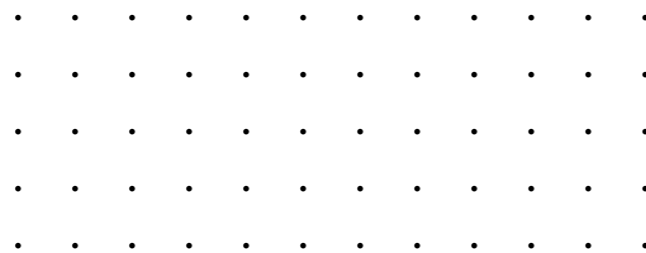

P-230 + R4-200 Louvres + Iras glass curtain + Eris Shutters

## ► P-230 + Eris Shutters

By combining the Eris Shutters with the Bioclimatic Pergola, we can easily open up the space, easily moving its leaves, which allows us to control the excess of light and increase the sensation of privacy.

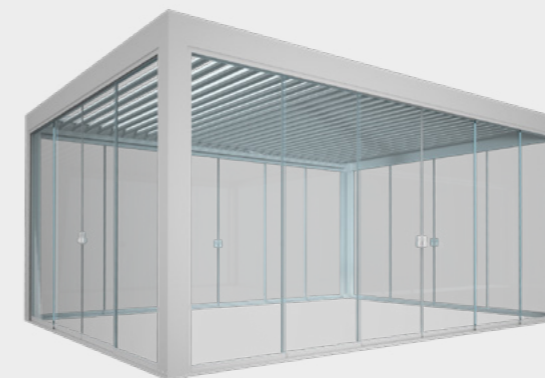
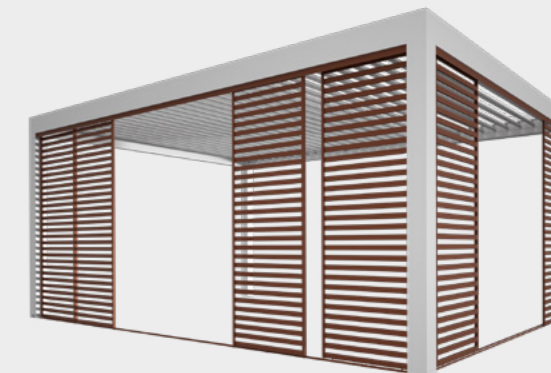

## ◀ P-230 + Iras glass curtain

The glass curtains protect the interior space of the Bioclimatic Pergola, so that you feel the comfort of an interior room without giving up the views and luminosity of the exterior.

## ► P-230 + Wind Screen

The complementary installation of our Wind Screen creates a barrier against the most horizontal solar incidence, providing extra privacy for the most intimate moments.



## ◀ P-230 + R4-200 Louvers

The straight-lined design of the R4-200 rectangular slats integrate seamlessly into the Bioclimatic Pergola. Its lacquered finish in wood colours give the space a sense of warmth and protection.

**saxun**  
by Giménez Ganga

Giménez Ganga, S.L.U.  
Polígono Industrial El Castillo  
C/ Roma, 4  
03630 • Sax (Alicante) • Spain

[saxun.com](http://saxun.com)



Your world,  
our universe.

